

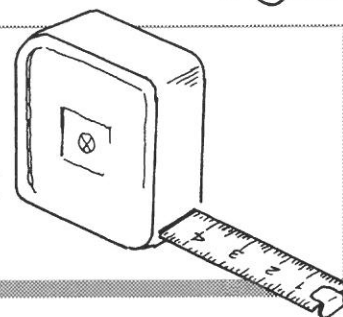

Materialer

målebånd



Luk det ene øje.
Hvor tæt på kan du læse dette?

Med venstre øje _____ cm Med højre øje _____ cm

På hvor stor afstand
kan du se bogstaverne på synstavlen?

Række	Med venstre øje	Med højre øje
A		
B		
C		
D		

I hvilken afstand bliver felterne grå?

Felt	Med venstre øje	Med højre øje
E		
F		



Navn:

Klasse:

Dato:



A d r p t o

B f a g u j

C b m x v æ

D e k l t p

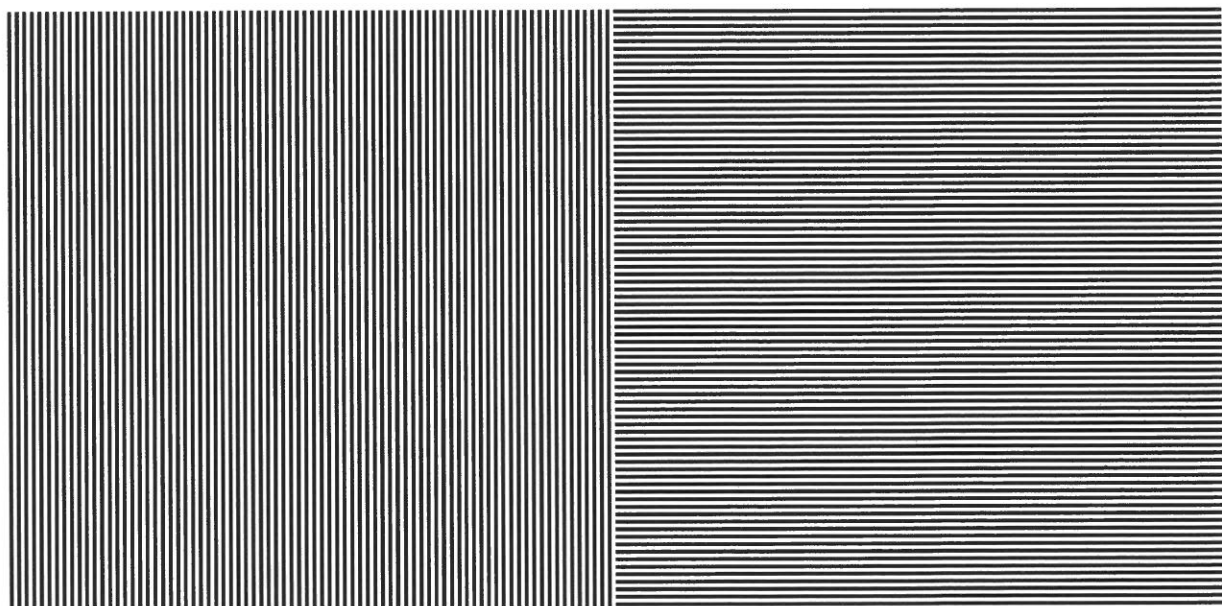

E

F

Navn:

Klasse:

Dato:



Luk det ene øje.

Materialer

ståltråd



papir-kurv

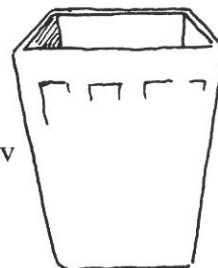

papir-kugle

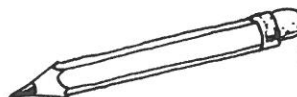

blyant

Kan du få blyanten gennem hullet?



Sig stop, når bolden er lige over kurven.
Prøv også med begge øjne åbne.

Navn:

Klasse:

Dato:

Brug næsen



Find genstande, der *ikke* lugter.

Klassen mener:

Genstande

ja

nej

Genstande	ja	nej

Navn:

Klasse:

Dato:



Hold dig for øjnene.

Materialer

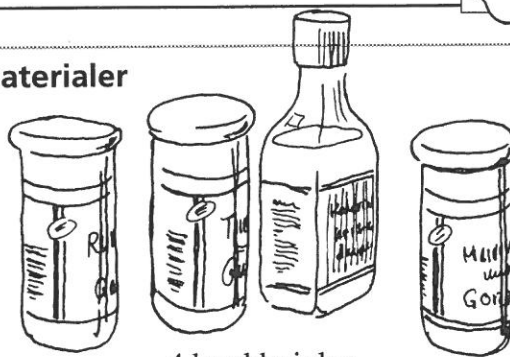

4 krydderiglas
eller andet der lugter



Din kammerat vælger et glas,
du skal lugte til.

Kender du lugten?



Kan du finde glasset?



Navn:

Klasse:

Dato:



Materialer



noget, der lugter

Find noget der lugter.
Læg det i et bæger.
Forudsig, hvor lang tid det vil lugte.

Gæt	Genstand	Forsøg
	Vat med sprit	
	Kaffe-pulver	

Navn:

Klasse:

Dato:



Materialer



lugte-dåser

Klem på en dåse.
Hvad lugter den af?

Dåse	Jeg tror det er:	Det var:
1		
2		
3		
4		
5		

Navn:

Klasse:

Dato:



Find to dåser med samme lugt.

Materialer

lugtedåser, 2 sæt

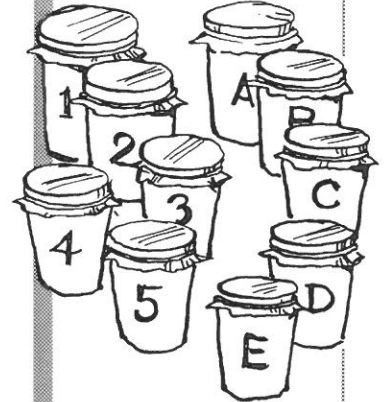

Tegn streger imellem dem.

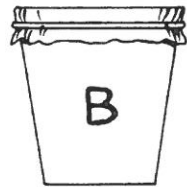
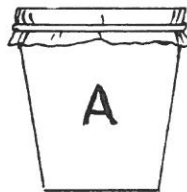

Navn:

Klasse:

Dato:

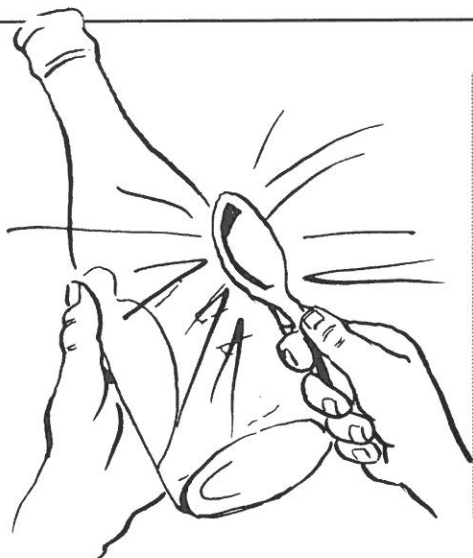

Materialer

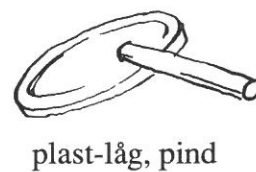

Lyt til de fem lyde.



Luk så øjnene.
Gæt, hvad der lavede lyden.



Navn:

Klasse:

Dato:

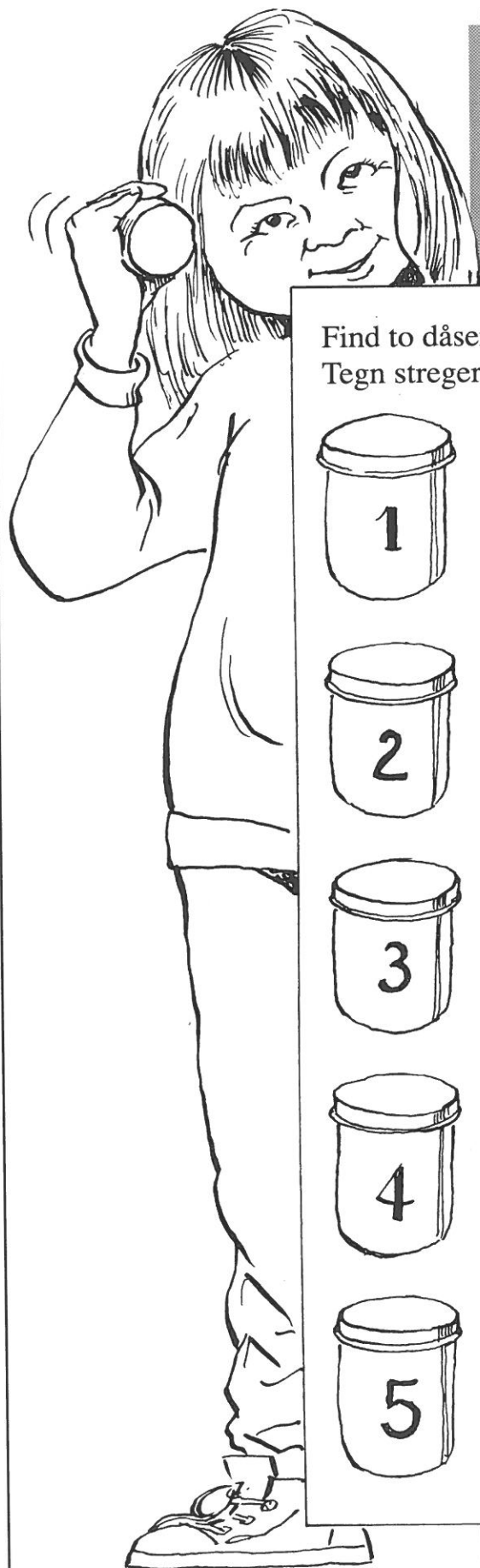

Materialer



rasle-dåser, 2 sæt

Find to dåser med samme lyd.
Tegn streger imellem dem.

Hvad var der i dåserne?











Navn:

Klasse:

Dato:



Materialer

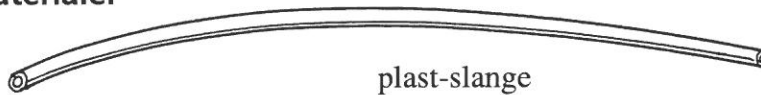

plast-slange

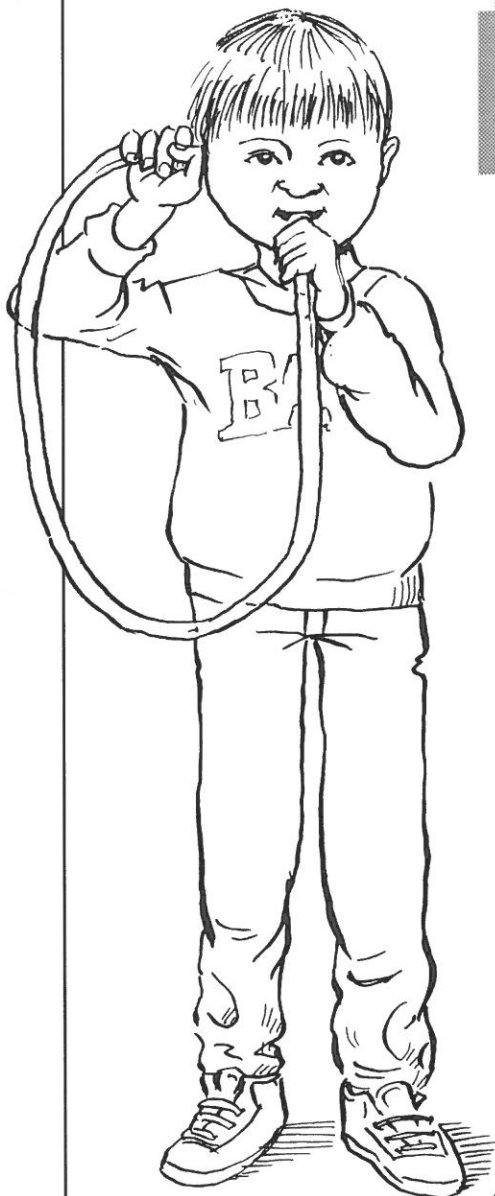

Snak med dig selv.

Lyt til noget.

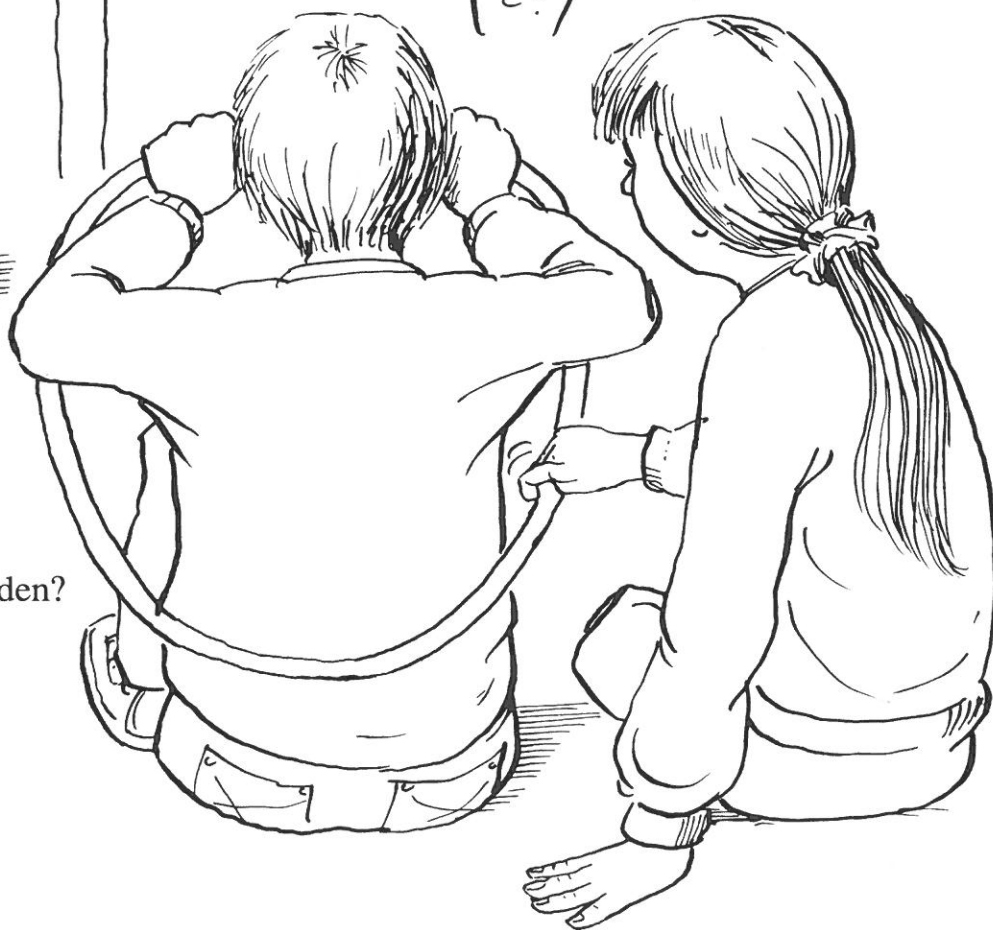

Hvilket øre hører lyden?

Navn:

Klasse:

Dato:



Se på sukker og salt i en lup.
Kan du smage et enkelt korn?

1 korn sukker _____ ja _____ nej

1 korn salt _____ ja _____ nej

Materialer



sukker



salt

bæger

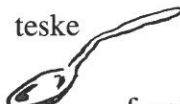

teske

frugt-saft



citron-saft

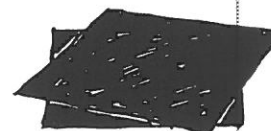

mørkt papir

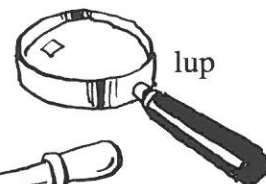

lup

pipette

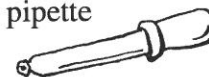

Kom vand
i bægret.



Dryp en dråbe
saft i.

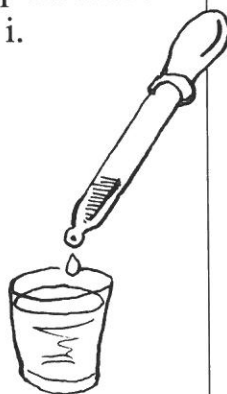

Rør rundt.



Smag
en teskefuld.



Kan du smage 1 dråbe?

Citron-saft

1 dråbe _____ ja _____ nej

_____ dråber _____ ja

Hvor mange dråber skal der til?

Frugt-saft

1 dråbe _____ ja _____ nej

_____ dråber _____ ja

Hvor mange dråber skal der til?

Navn:

Klasse:

Dato:



Byg en lille figur af
3 lego-klodser.

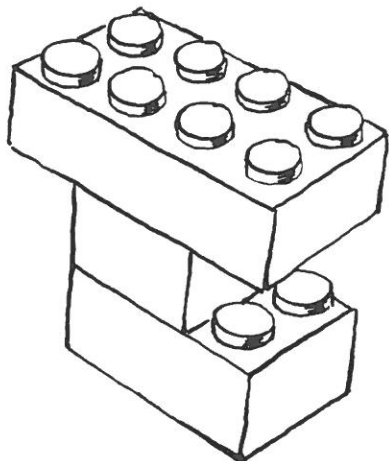

Materialer

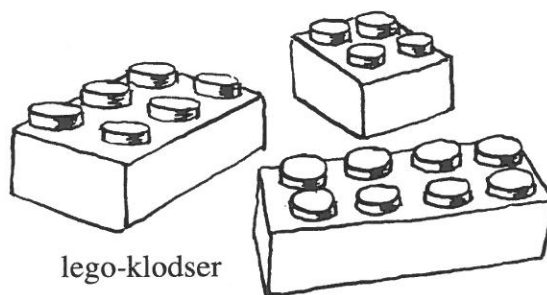

lego-klodser

Kan din kammerat
bygge en figur mæge til
– med bind for øjnene?



Prøv med en anden figur.

Navn:

Klasse:

Dato: