



Materialer



pære



fatning

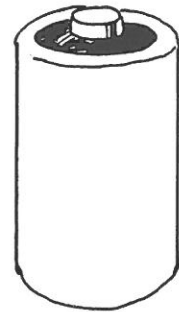

batteri

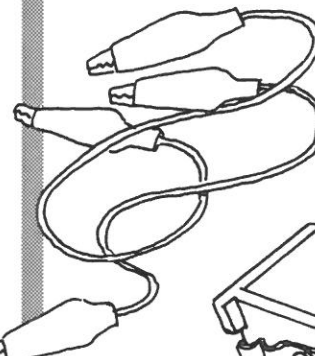

2 ledninger

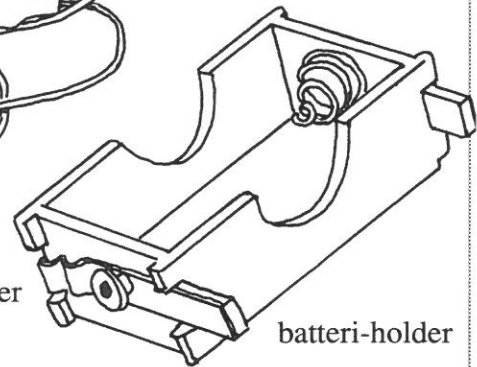

batteri-holder

Hvordan fik du pæren til at lyse?

Tegn.

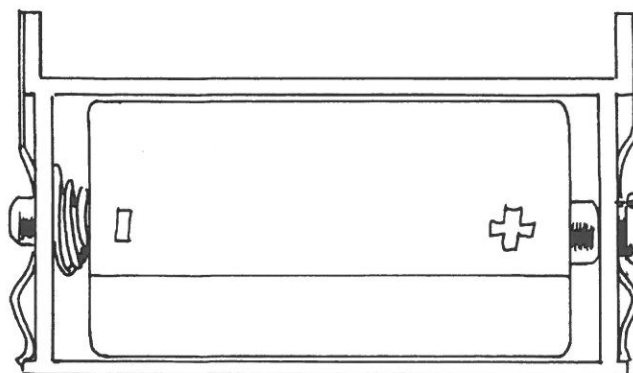

Navn:

Klasse:

Dato:

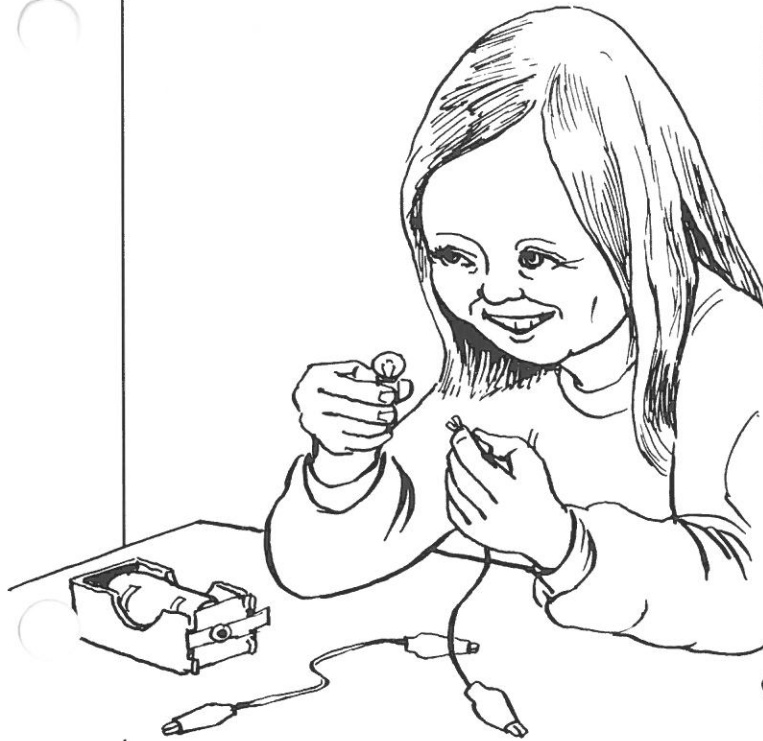

Materialer

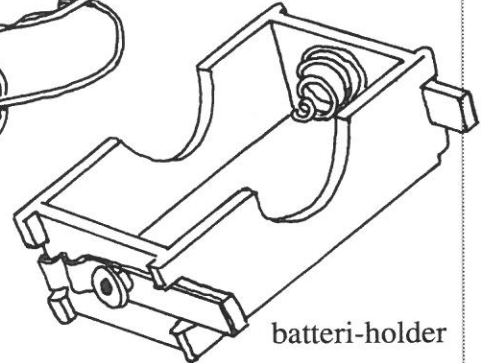
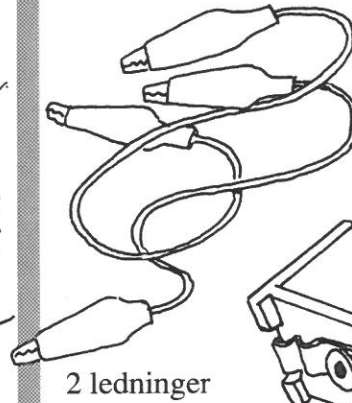
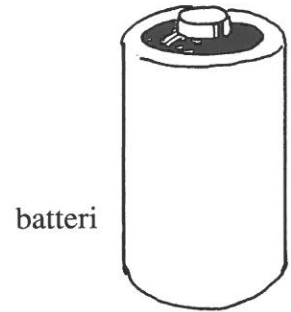

Hvordan får du pæren til at lyse nu?

Tegn.

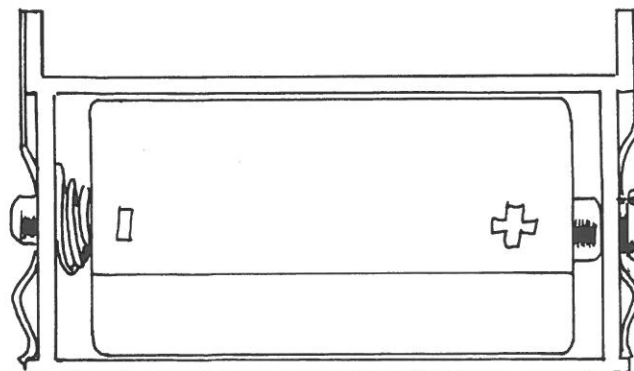

Navn:

Klasse:

Dato:

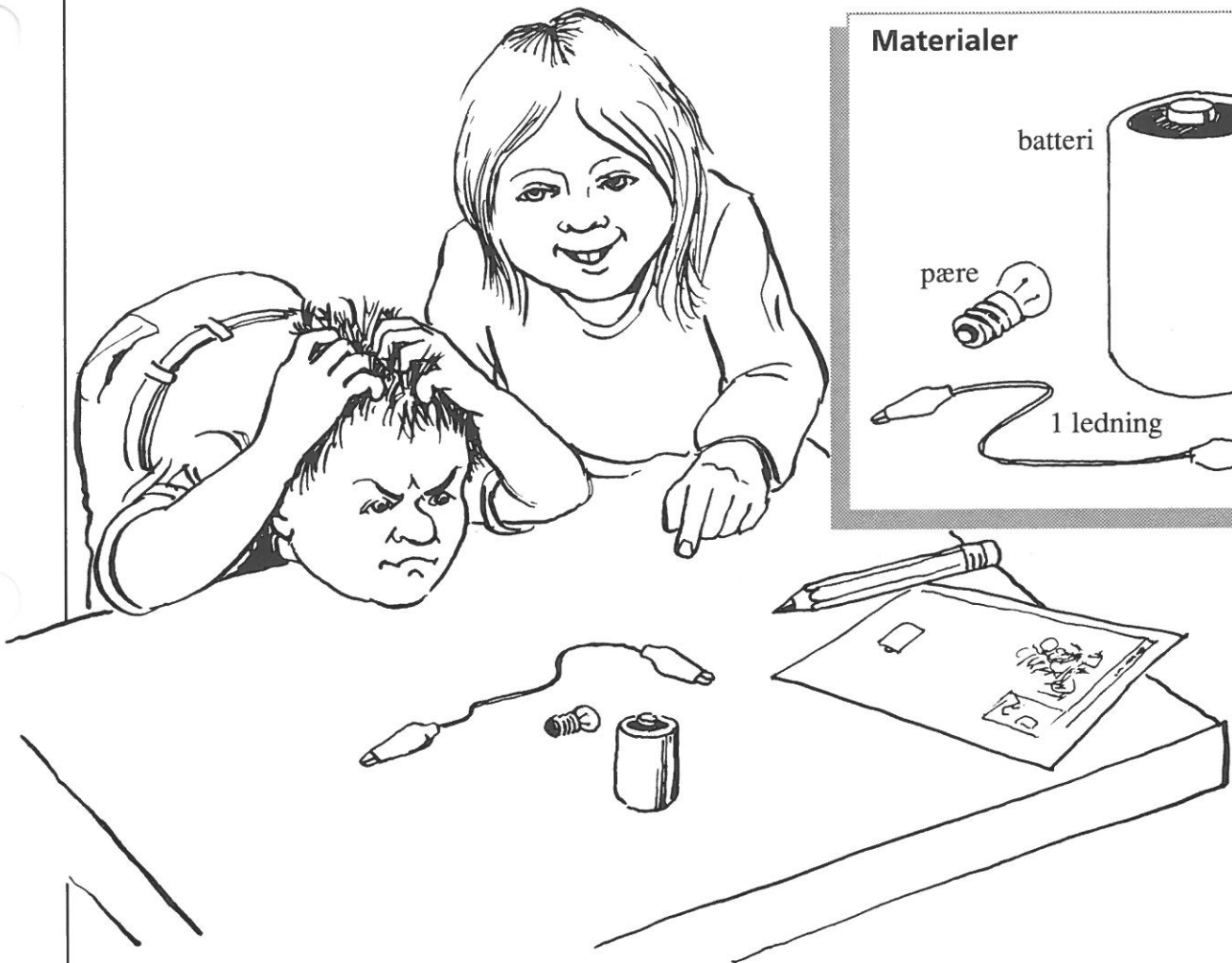
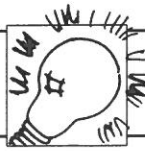

Hvordan får du pæren til at lyse nu?

Tegn.

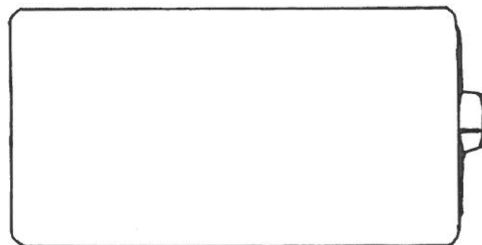

Navn:

Klasse:

Dato:

Forudsig, hvordan pærene lyser (kraftigt, normalt, svagt, slukket).
Skriv det ved pærene.

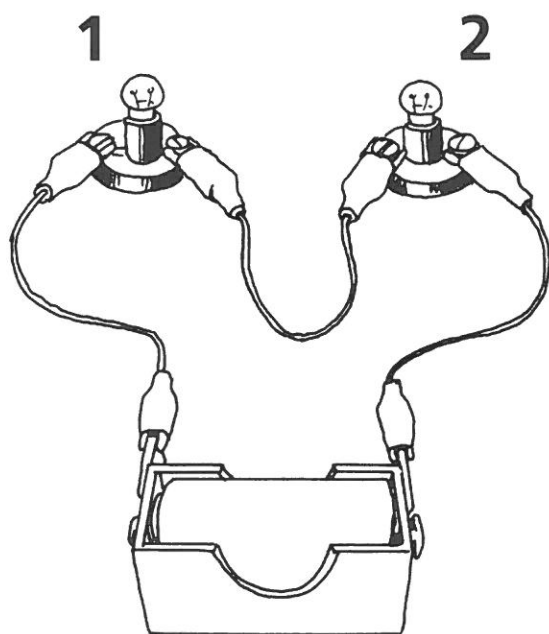

Byg kredsen.

Pære 1 _____

Pære 2 _____

Hvordan lyser pære 2,
hvis pære 1 skrues løs?

Forudsig: Pære 2 _____

Prøv så: Pære 2 _____

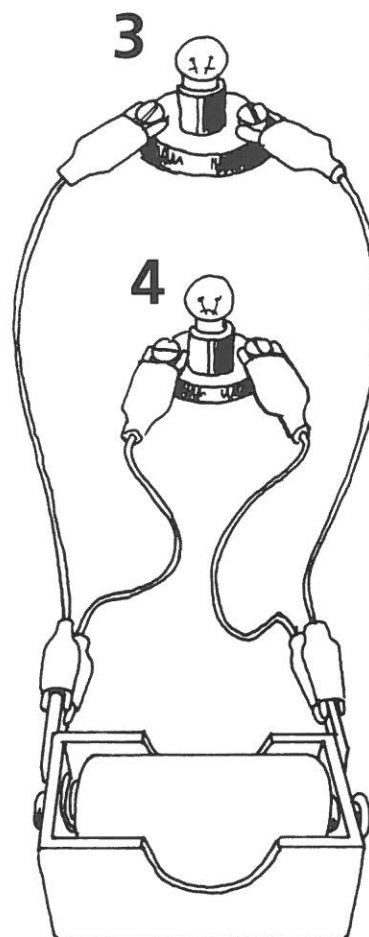

Pære 3 _____

Pære 4 _____

Hvordan lyser pære 4,
hvis pære 3 skrues løs?

Forudsig: Pære 4 _____

Prøv så: Pære 4 _____

Navn:

Klasse:

Dato:

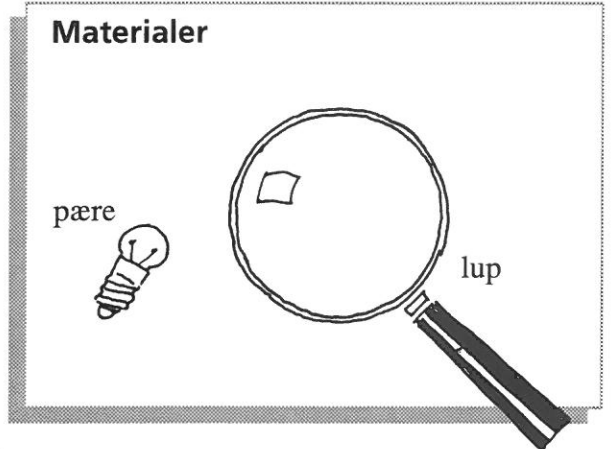
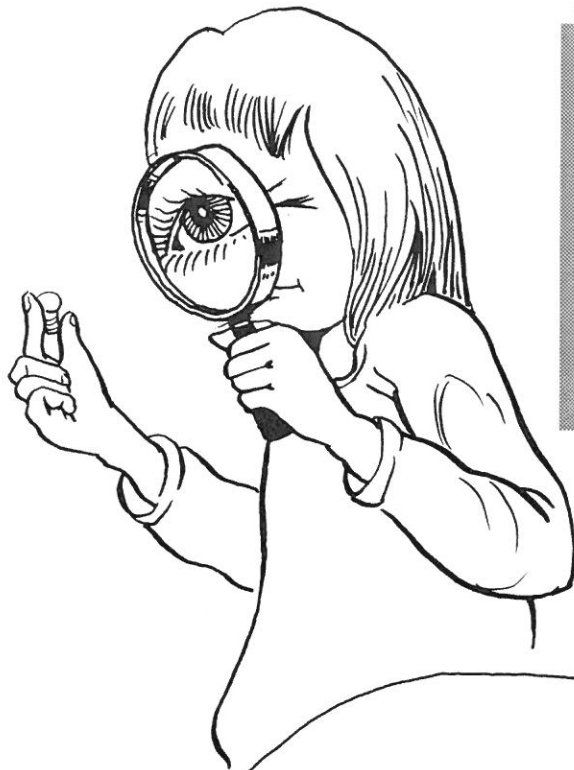

Hvad er der inde i pæren?

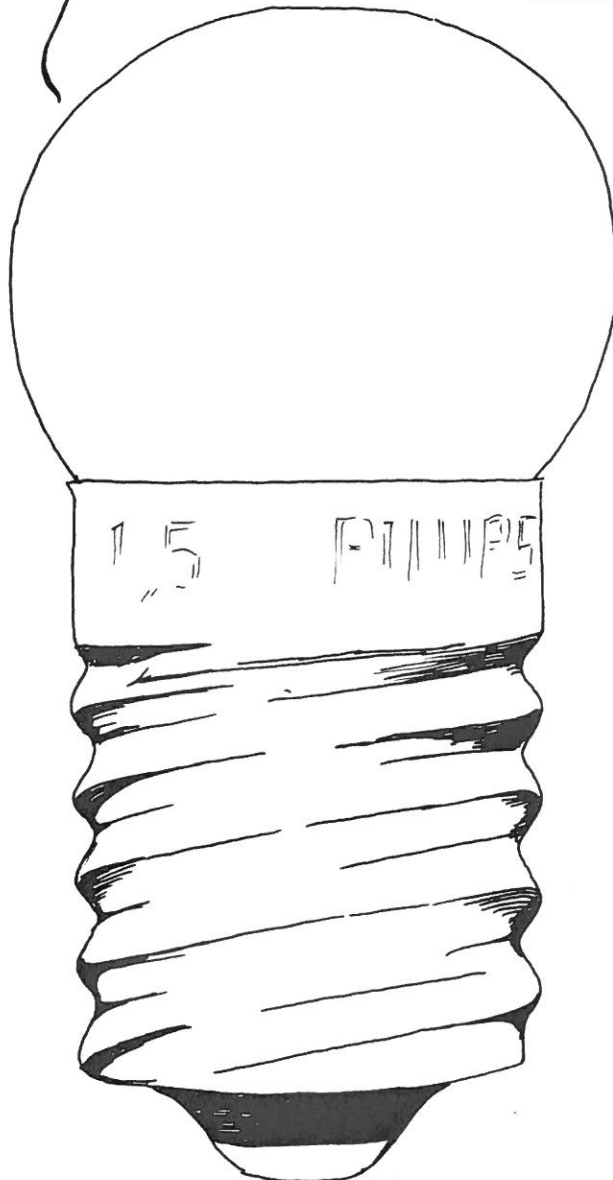

Navn:

Klasse:

Dato:



Materialer

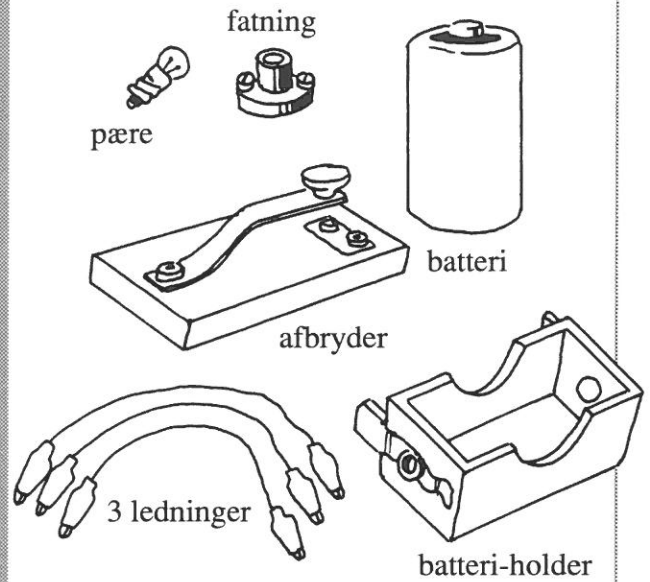

Kan du tænde og slukke pæren med en afbryder?

Tegn.

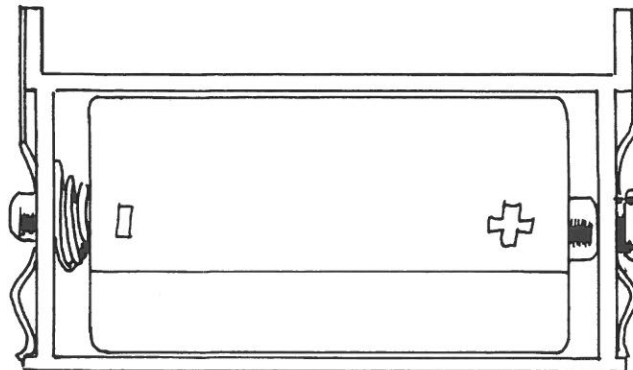

Lav selv en afbryder.

Navn:

Klasse:

Dato:

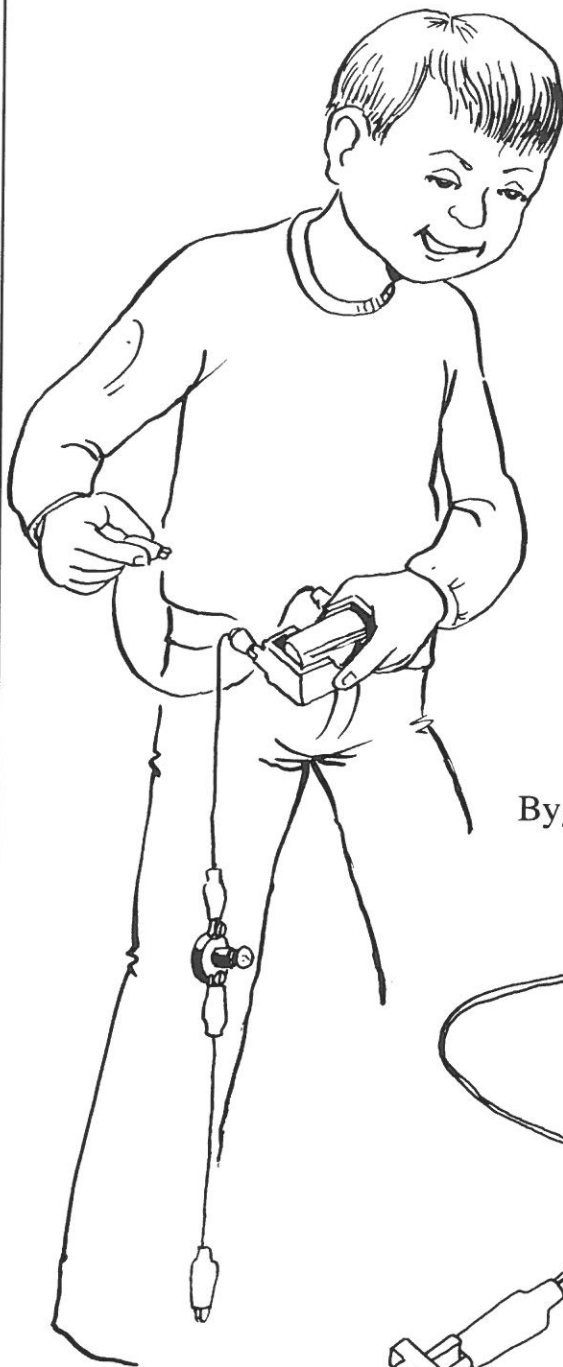

Materialer



pære

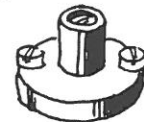

fatning

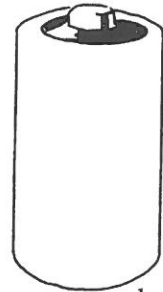

batteri

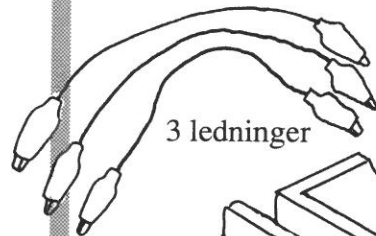

3 ledninger

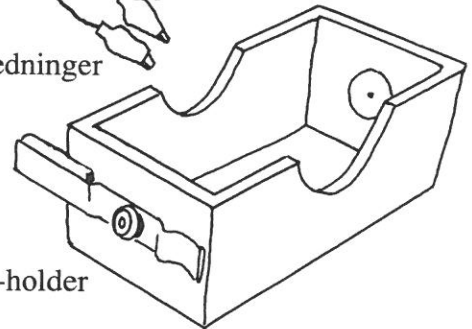

batteri-holder

Byg en prøve-kreds sådan:

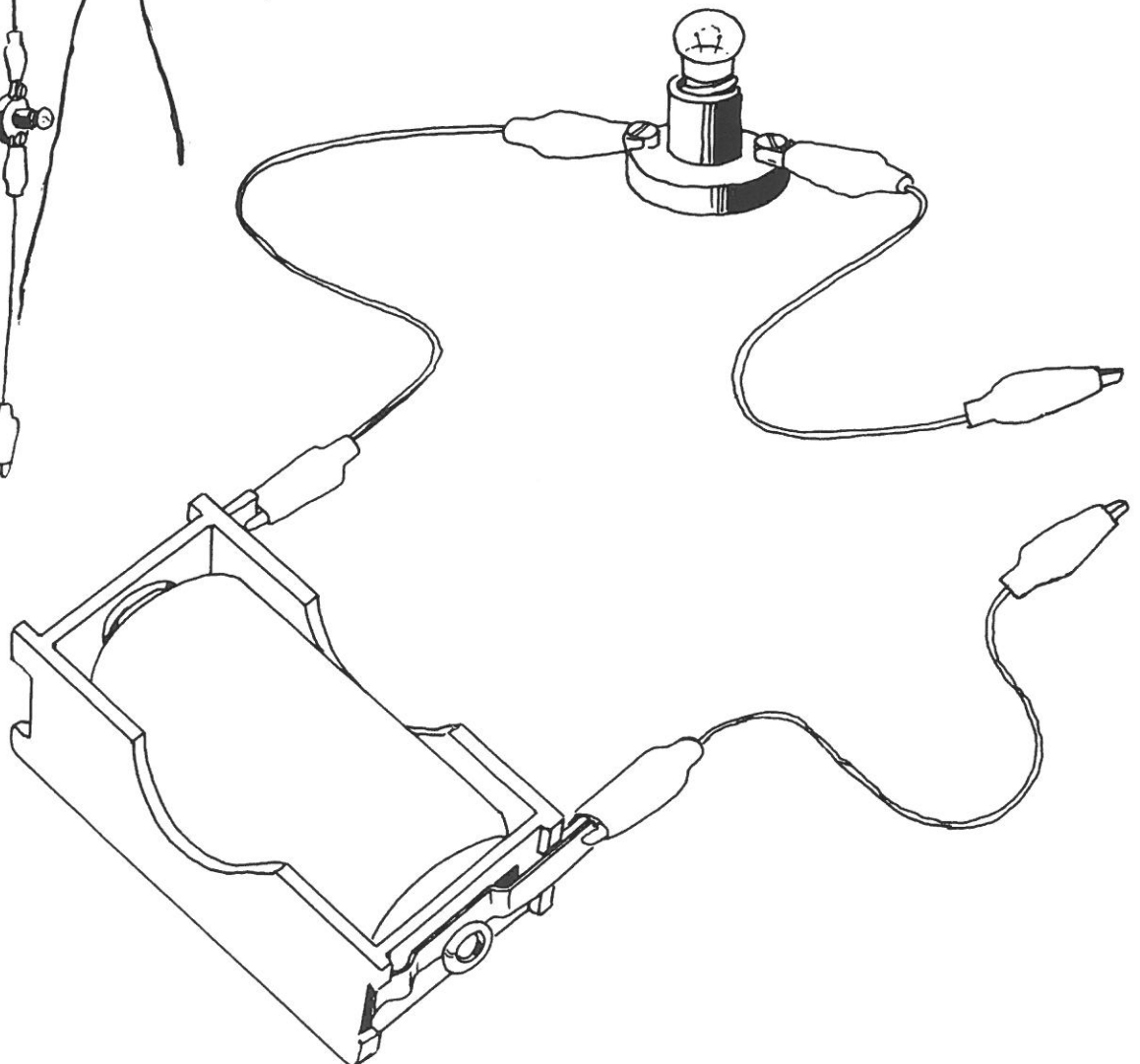

Navn:



Klasse:

Dato:

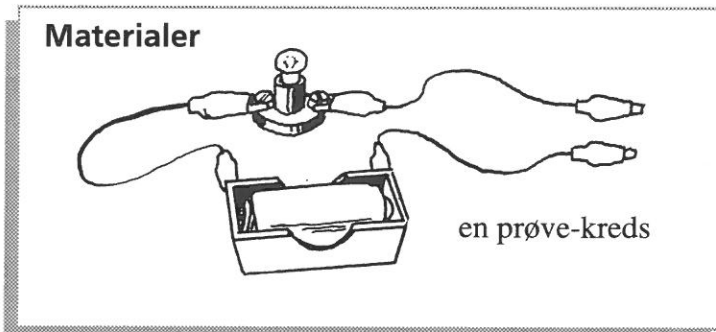
Brug prøve-kredsen

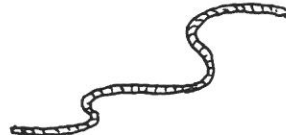

Hvilke genstande kan lukke en kreds?

Genstand		 lyser	 lyser ikke
søm		+	
snor			-

Navn:

Klasse:

Dato:

Hemmelige forbindelser



Materialer

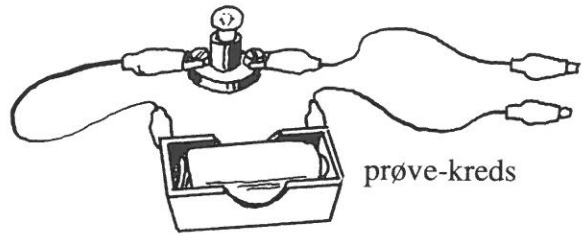

prøve-kreds

el-konvolutter

<input type="radio"/>	<input type="radio"/>	<input type="radio"/>
A	B	C
nr. _____		
<input type="radio"/>	<input type="radio"/>	<input type="radio"/>
D	E	F

Hvor er der forbindelse?

Brug din prøve-kreds.

Hvor tror du ledningerne er?

Tegn dem.

nr. _____

A

B

C

D

E

F

nr. _____

A

B

C

D

E

F

Navn:

Klasse:

Dato:

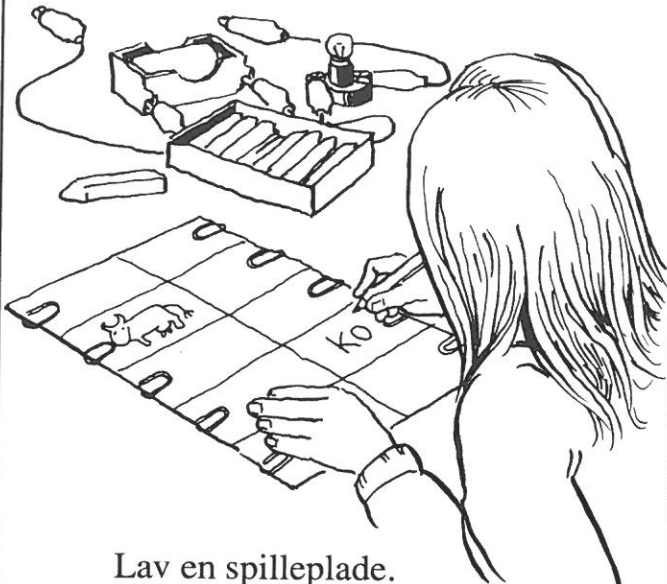
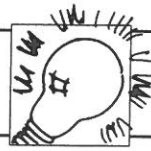

Lav en spilleplade.

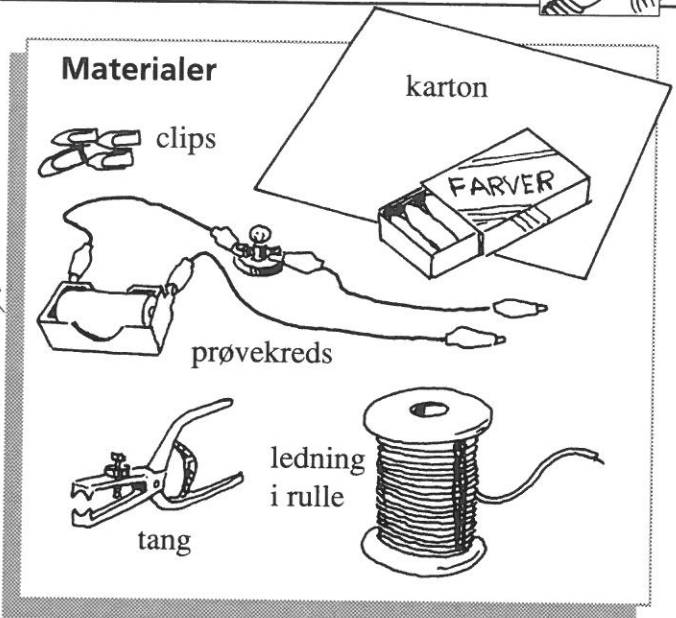

Forside
Skriv dine opgaver her:

Bagside
Tegn dine ledninger her:

Navn:

Klasse:

Dato: