

Tegn og skriv om dine forsøg.

Navn:

Klasse:

Dato:

Hvad virker magneten på?

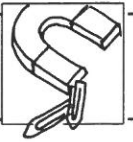

Materialer

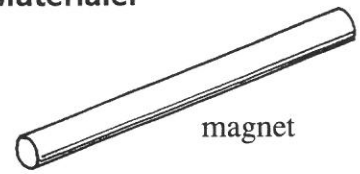

magnet

Prøv:

Sæt kryds:

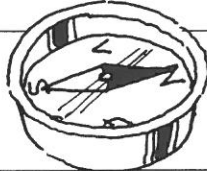
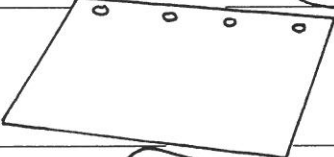
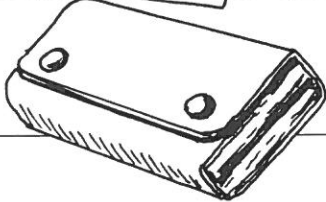
Genstand	Virker	Ingen virkning
 <p data-bbox="842 788 965 831">kompas</p>	X	
 <p data-bbox="842 929 927 972">papir</p>		X
 <p data-bbox="842 1070 986 1113">penalhus</p>		

Navn:

Klasse:

Dato:

Magnet og clips

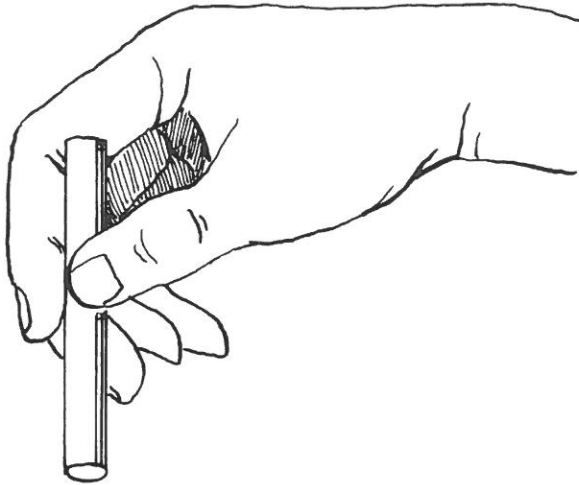
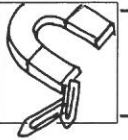

Materialer

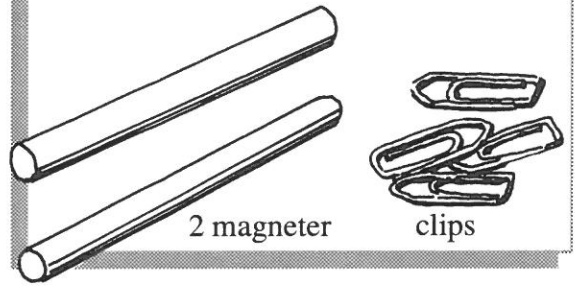

2 magneter

clips

Hvor mange clips kan hænge fast?

Største antal _____



Er det bedre med 2 magneter?

Prøv sådan

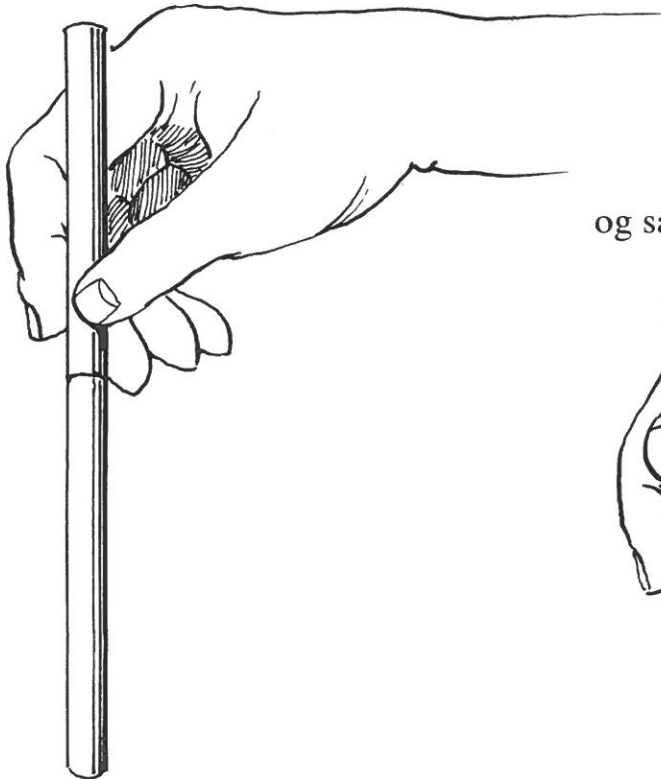

og sådan.

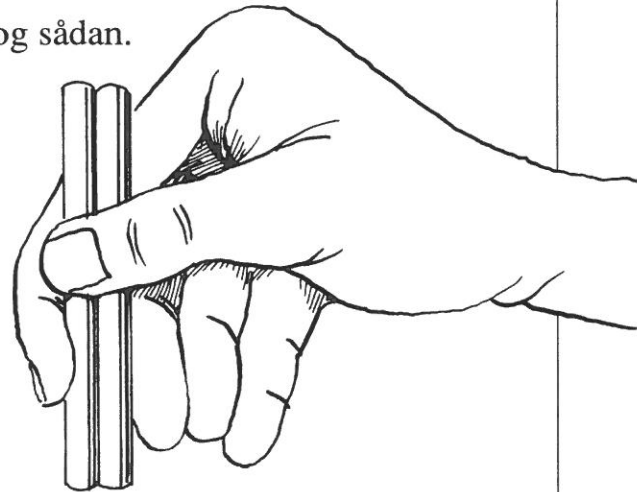

Antal _____

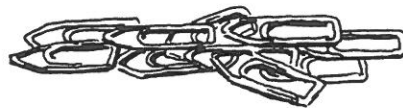

Antal _____

Virker magneter også under vand?

Navn:

Klasse:

Dato:

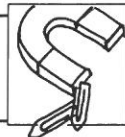

Materialer

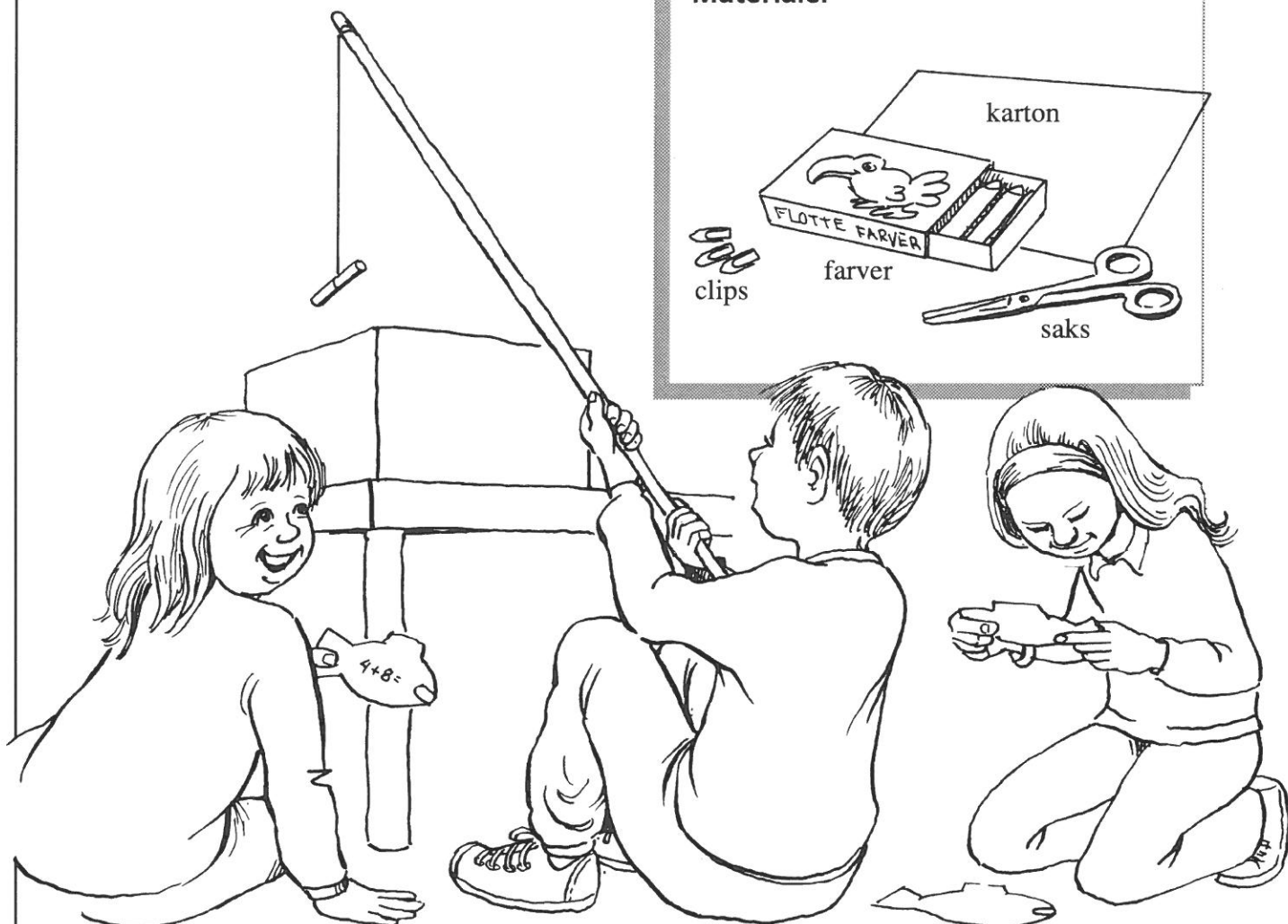
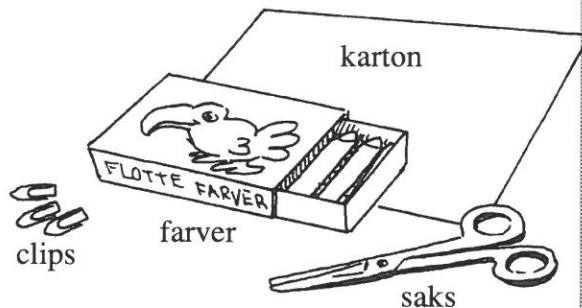

Lav en fisk af karton.

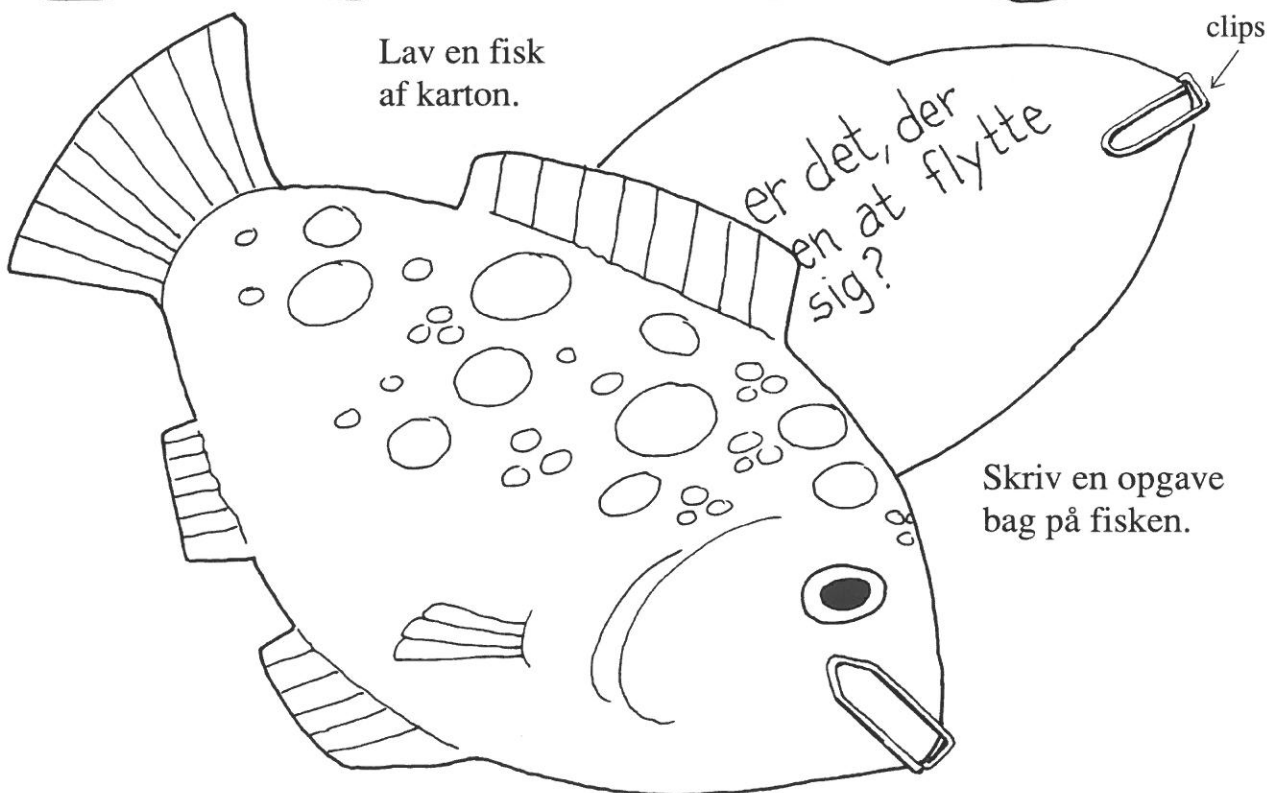

Skriv en opgave bag på fisken.

Navn:

Klasse:

Dato:

Magnet-føler 1

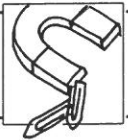

Materialer

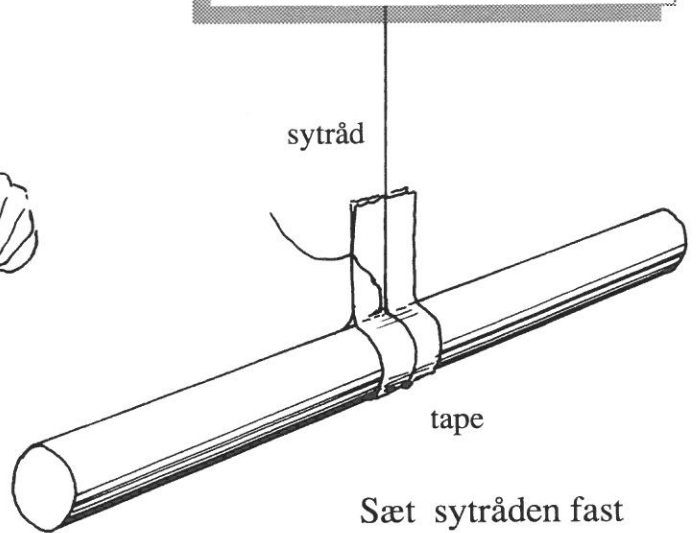
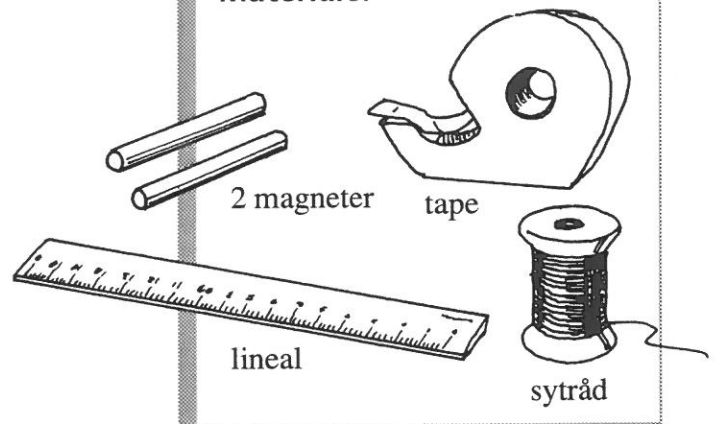

Sæt sytråden fast midt på magneten med tape.



Lad din magnet hænge helt stille. Kan den mærke en anden magnet?

På hvor stor afstand?

_____ cm

Navn:

Klasse:

Dato:

Magnet-føler 2

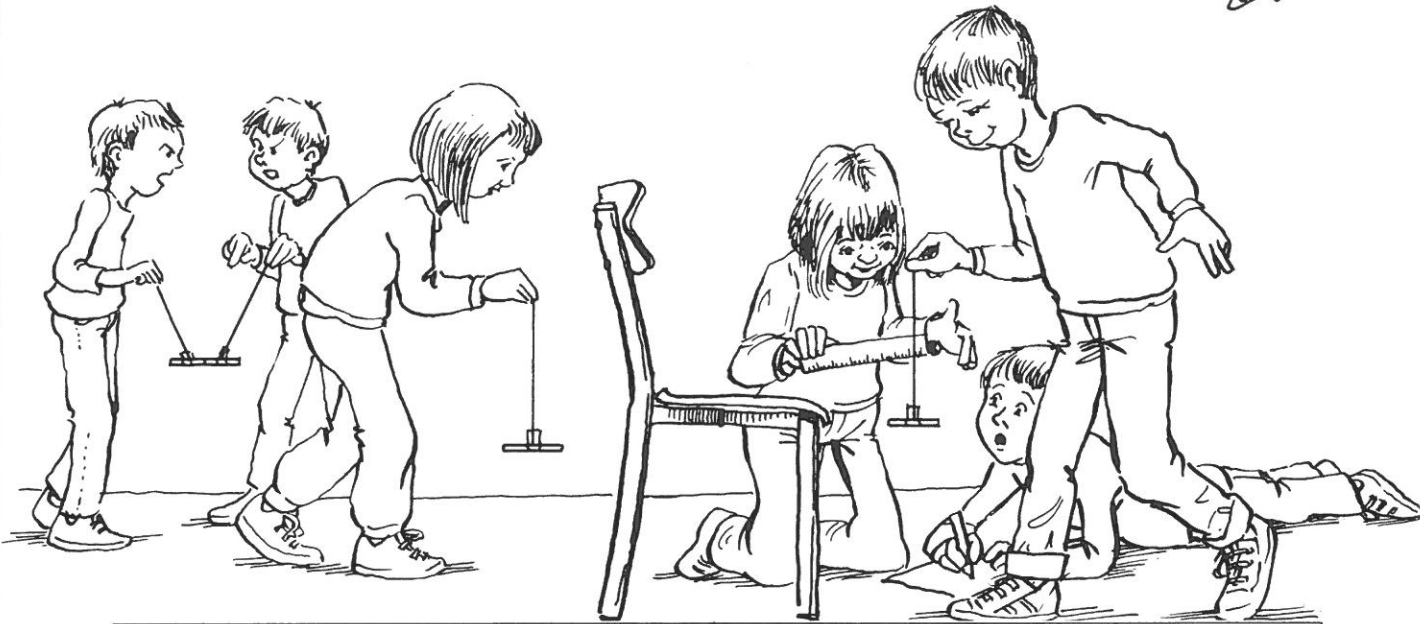
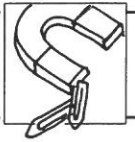

Genstand	Afstand

Navn:

Klasse:

Dato:

Skjulte genstande

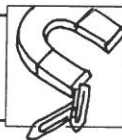

9



Materialer

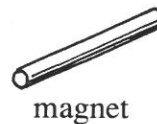

magnet



kompas

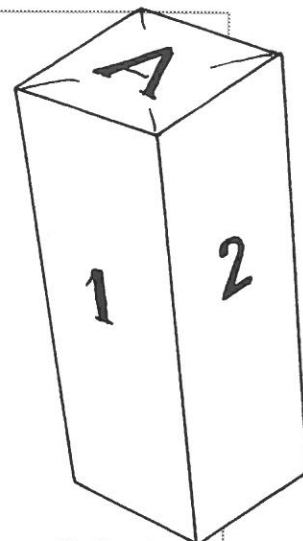

„hemmelig“ æske

Hvad kan du finde?

Brug en magnet
eller et kompas.

Tegn hvad du finder.

Æske _____

1

2

3

4

Navn:

Klasse:

Dato:

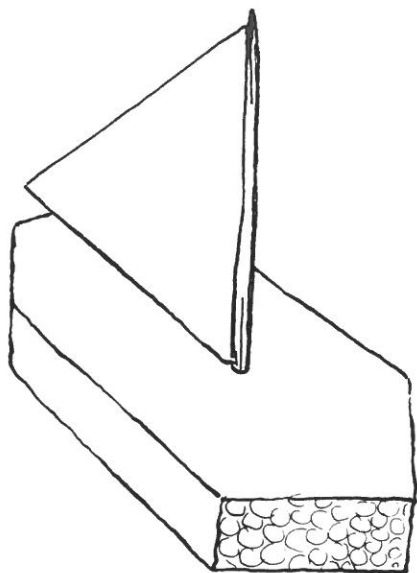
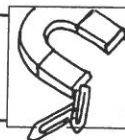

Lav et lille skib.

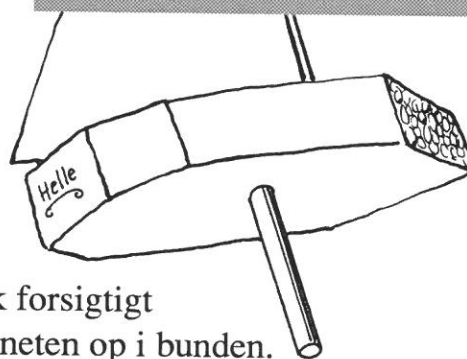
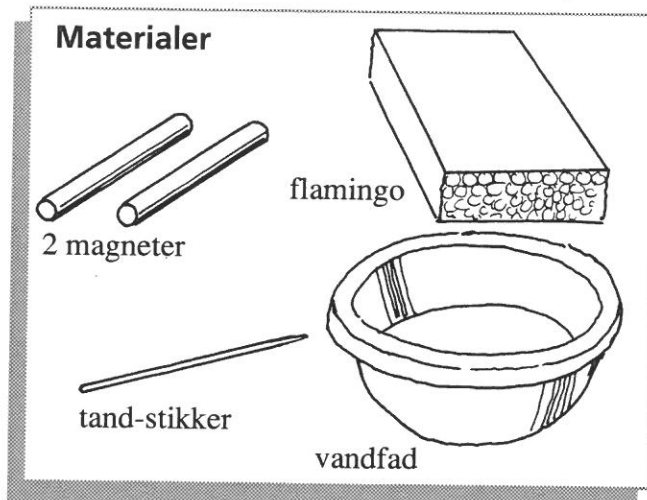

Tryk forsigtigt
magneten op i bunden.
Den skal sidde fast.

Kan skibet sejle?

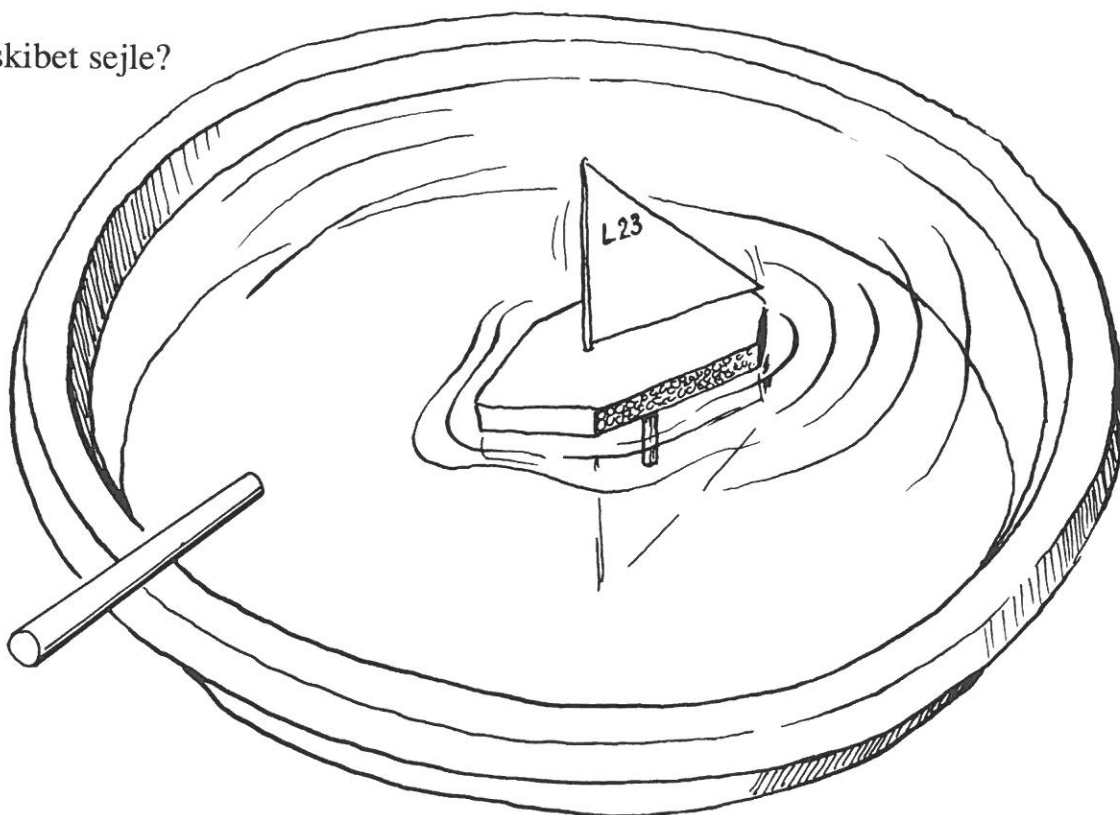

Kan I styre det med en anden magnet?
Hen mod magneten? Væk fra magneten?

Navn:

Klasse:

Dato:



Materialer



magnet

clips



A4-karton



saks

4 cm

papir

Lav først tunnel-stykker af papir.

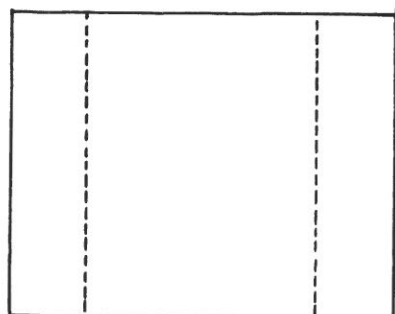

1 cm 3 cm 1 cm
tunnel-stykke

4 cm

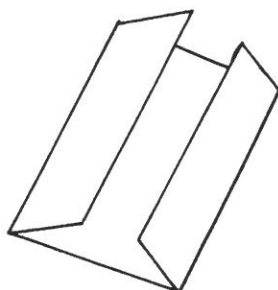

fold

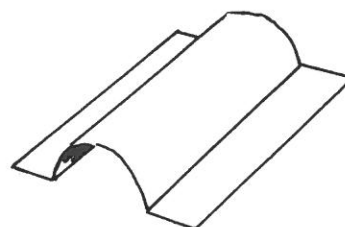

bøj

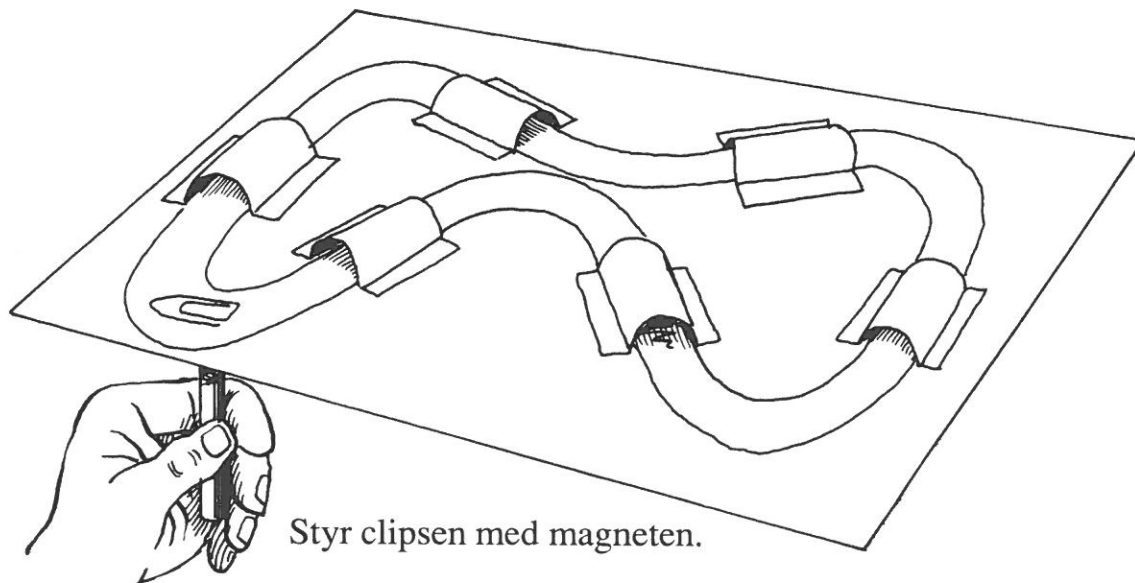

Styr clipsen med magneten.

Navn:

Klasse:

Dato:

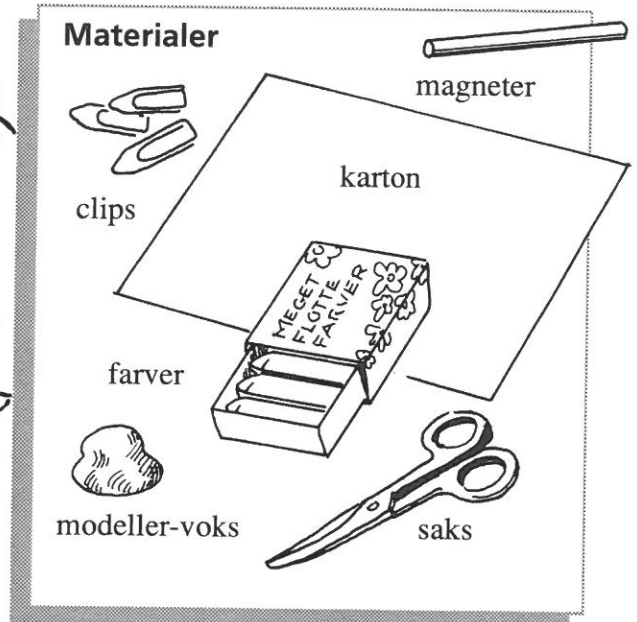
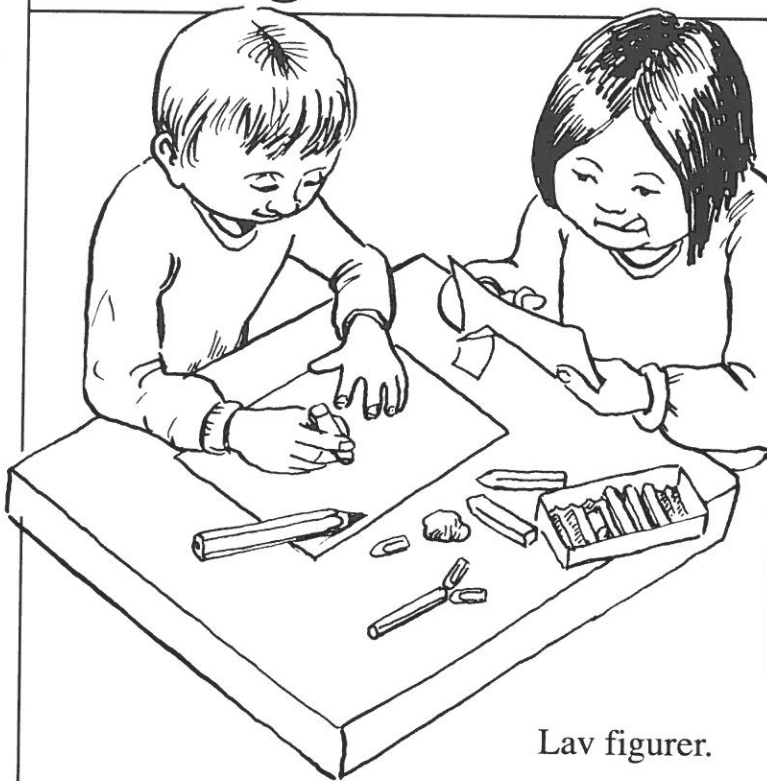
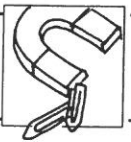

Lav figurer.

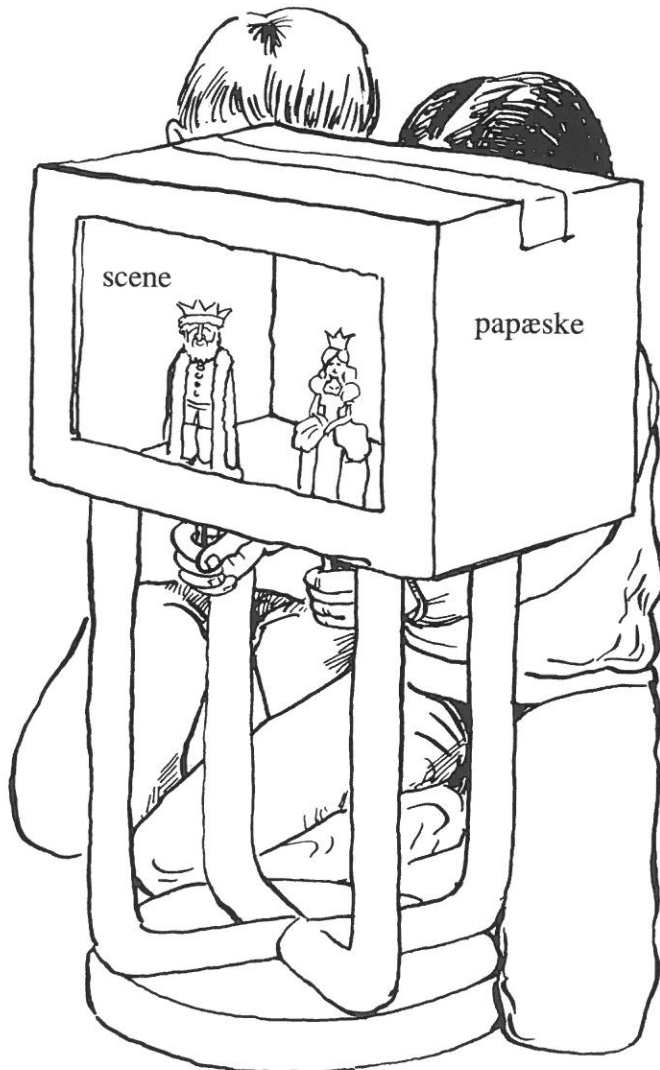

modeller-voks med clips under



Navn:

Klasse:

Dato: